

Custom Driver Protection Systems (DPS)

INFORMATION SHEET

nfi.parts™

MCI

NEW FLYER

TRANSIT APPLICATION

AROWGuard Custom Solution Available for all bus and coach models.

Application: Assault and Virus Protection
Fit: The Custom DPS is designed to each customer's specific configuration requirements
Cost: Dependent on style, design, and order volume

DPS is compliant with
American National Standard
for Safety Glazing Materials
(ANSI) /SAE Z26.1- 1996
standards.



FEATURES

- Fixed door slide system that incorporates a sliding two-piece glass system.
- Allows drivers to select a glass position in the same manner as a driver's window.
- Easy to close and protect the driver.
- Utilizes a time-tested and robust rocker latch.
- Incorporates a hinge design, free of pinch points and rattling.
- Standard and Extended sash options.
- Uses AS2 Glass with OptiView anti-glare coating
- Long-term solution providing both health and safety benefits.

Configuration Possibilities



DESIGNED TO FIT NEW FLYER, MCI, NABI, GILLIG, NOVA, ADL, AND OTHERS

Benefits of NFI Parts Support on Retrofit Projects

- Experts in design
- Ease of design process
- Experience in custom design
- Onsite support
- Full life-cycle product support

*Lead times start at day 1 and do NOT include customer testing/approval time. Information on this sheet is subject to change at the discretion of NFI Parts and/or its affiliates. Contact your NFI Parts solutions manager or customer service representative for further details. All product names, trademarks, and registered trademarks are property of their respective owners. NFI Parts disclaims any proprietary interest in the marks and names of others.

nfi.parts™
www.nfi.parts

NEW FLYER

U.S. & Canada
800.665.2637

MCI

U.S. 800.323.1290
Canada 800.665.0155
partsstore.nfi.parts

Universal Xcelsior Driver Protection Systems (DPS)

INFORMATION SHEET

nfi.parts™

MCI

NEW FLYER

TRANSIT APPLICATION

AROWGuard Universal Xcelsior Solution

Available for New Flyer Xcelsior buses

Application: Assault and Virus Protection

Fit: Universal Xcelsior design fits around most farebox installations, may require minor adjustments to install

Cost: Dependent on Style (STD or EXT) and volume

DPS is compliant with American National Standard for Safety Glazing Materials (ANSI) /SAE Z26.1- 1996 standards.



AROWGuard Slide Door System

FEATURES

- Fixed door slide system that incorporates a sliding two-piece glass system.
- Allows drivers to select a glass position in the same manner as a driver's window.
- Easy to close and protect the driver.
- Utilizes a time-tested and robust rocker latch.
- Incorporates a hinge design, free of pinch points and rattling.
- Uses AS2 Glass with OptiView anti-glare coating
- Standard and Extended sash options.
- Long-term solution providing both health and safety benefits.

NFI Part No.	Description	Options
6483564	DPS-UNIVERSAL XCELSIOR EXT/SLIDE	Extended Glass Profile
6483561	DPS-UNIVERSAL XCELSIOR STD/SLIDE	Standard Glass Profile
6483572	STANCHION KIT-NO PEDESTAL DPS STD XCELSIOR	Floor Mounting
6483567	STANCHION KIT-W/ PEDESTAL DPS STD XCELSIOR	Pedestal Mounting

Benefits of NFI Parts Support on Retrofit Projects

- Experts in design
- Ease of design process
- Onsite support
- Full life-cycle product support

Information on this sheet is subject to change at the discretion of NFI Parts and/or its affiliates. Contact your NFI Parts solutions manager or customer service representative for further details. All product names, trademarks, and registered trademarks are property of their respective owners. NFI Parts disclaims any proprietary interest in the marks and names of others.

nfi.parts™
www.nfi.parts

NEW FLYER

U.S. & Canada
800.665.2637

MCI

U.S. 800.323.1290
Canada 800.665.0155
partsstore.nfi.parts

Universal Xcelstor Driver Protection Systems (DPS) INFORMATION SHEET

nfi.parts™

MCI

NEW FLYER

TRANSIT APPLICATION

AROWGuard Universal Xcelstor Solution

Available for New Flyer Xcelstor buses.

Application: Assault and Virus Protection

Fit: Universal Xcelstor design fits around most farebox installations, may require minor adjustments to install

Cost: Dependent on Style (STD or EXT) and volume

The AROWGuard Universal Xcelstor DPS

Available in 2 options.

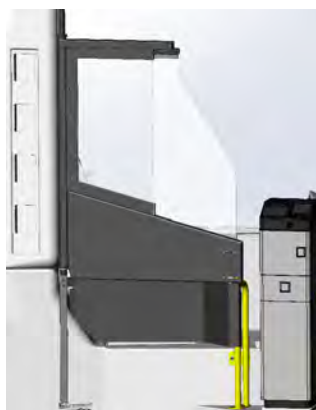

Standard glass 6483561

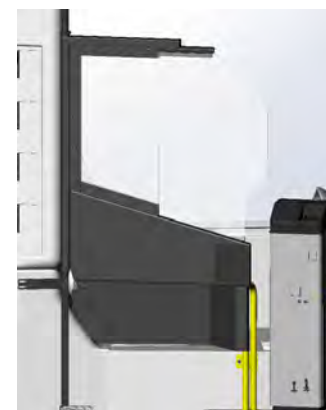

Extended glass 6483564

There are 2 Options for Stanchion Kits

Must be ordered 1 for each DPS kit to complete the install.

Vehicles with an existing Farebox Pedestal as highlighted in the left image below must order the Pedestal Mount Kit. All others should use the Floor Mount Kit as shown in the right image below.



Pedestal Mount Stanchion Kit 6483567



Floor Mount Stanchion Kit 6483572

NFI Part No.	Description	Options
6483564	DPS-UNIVERSAL XCELSIOR EXT/SLIDE	Extended Glass Profile
6483561	DPS-UNIVERSAL XCELSIOR STD/SLIDE	Standard Glass Profile
6483572	STANCHION KIT-NO PEDESTAL DPS STD XCELSIOR	Floor Mounting
6483567	STANCHION KIT-W/ PEDESTAL DPS STD XCELSIOR	Pedestal Mounting

Information on this sheet is subject to change at the discretion of NFI Parts and/or its affiliates. Contact your NFI Parts solutions manager or customer service representative for further details. All product names, trademarks, and registered trademarks are property of their respective owners. NFI Parts disclaims any proprietary interest in the marks and names of others.

nfi.parts™
www.nfi.parts

NEW FLYER

U.S. & Canada
800.665.2637

MCI

U.S. 800.323.1290
Canada 800.665.0155
partsstore.nfi.parts

Universal Driver Protection Systems (DPS) for Gillig brand buses

INFORMATION SHEET

nfi.parts™

MCI

NEW FLYER

TRANSIT APPLICATION

AROWGuard Universal Gillig Solution

Available for 2007 and newer Gillig 35' and 40' buses

Application: Assault and Virus Protection

Fit: Universal Gillig design for buses 35' and 40' bus models from 2007 and on, fits around most farebox installations where farebox does not exceed 14" from front of dash, may require minor adjustments to install

Cost: Dependent on Style (STD or EXT) and volume

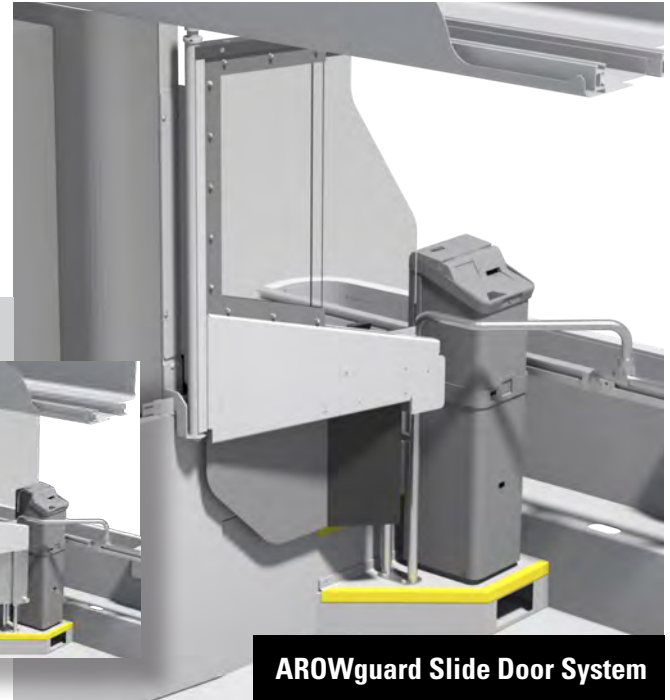
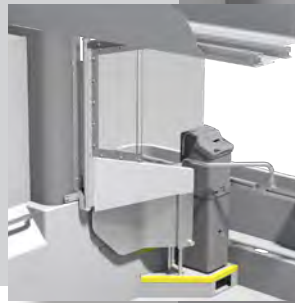

AROWguard Slide Door System

FEATURES

- Fixed door slide system that incorporates a sliding two-piece glass system.
- Allows drivers to select a glass position in the same manner as a driver's window.
- Easy to close and protect the driver.
- Utilizes a time-tested and robust rocker latch.
- Incorporates a hinge design, free of pinch points and rattling.
- Standard and Extended sash options.
- Long-term solution providing both health and safety benefits.
- Uses AS2 Glass with OptiView anti-glare coating
- DPS is compliant with American National Standard for Safety Glazing Materials (ANSI) /SAE Z26.1- 1996 standards.

The AROWGuard Universal Gillig DPS

Available in 2 options.



Standard glass 6483914



Extended glass 6483944

NFI Part No.	Description	Options
6483944	DPS-UNIVERSAL GILLIG 35/40-EXT/SLIDE	Extended Glass Profile
6483914	DPS-UNIVERSAL GILLIG 35/40-STD/SLIDE	Standard Glass Profile

Information on this sheet is subject to change at the discretion of NFI Parts and/or its affiliates. Contact your NFI Parts solutions manager or customer service representative for further details. All product names, trademarks, and registered trademarks are property of their respective owners. NFI Parts disclaims any proprietary interest in the marks and names of others.

nfi.parts™
www.nfi.parts

NEW FLYER

U.S. & Canada
800.665.2637

MCI

U.S. 800.323.1290
Canada 800.665.0155
partsstore.nfi.parts

SVP Driver Shield for Transit Buses

INFORMATION SHEET

nfi.parts™

MCI

NEW FLYER

TRANSIT APPLICATION

NFI Parts™ now offering new Driver Shield Kits

SVP
by NFI Parts

The SVP Driver Shield is compliant with American National Standard for Safety Glazing Materials (ANSI) /SAE Z26.1- 1996 standards.

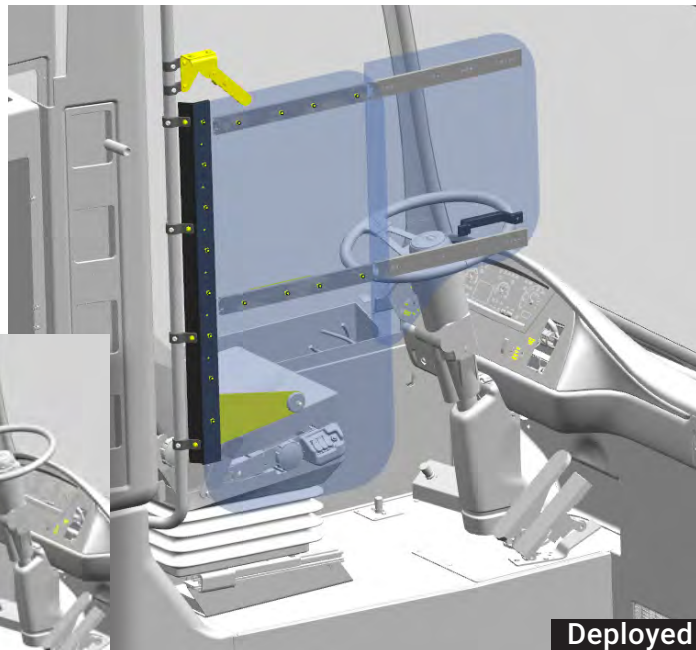

FEATURES

- Supports social distancing efforts
- Easy to install
- Permanent or temporary solution depending on your fleet needs
- Shield offers maximum driver coverage and protection
- All SVP shields are in compliance with ANSI Z26.1 and stamped with the DOT approval

Wide area of protection and farebox friendly



Curbside mirror view from drivers seat



(green cast shows stowed SVP Driver Shield
red cast shows room for farebox)

PN / Status	Description
6482699	DRIVER SHIELD KIT-XCELSIOR/LF/GIL
6483781	DRIVER SHIELD KIT-ORION
6483782	DRIVER SHIELD KIT-NABI
6483810	DRIVER SHIELD KIT-NOVA



6483715
KIT-STANCHION SVP BARRIER
(Needed if "snowball shield" is currently installed on Xcelsior platform. Allows mounting position of SVP Shield)

***CONTACT YOUR CUSTOMER SERVICE REPRESENTATIVE FOR OTHER MAKES AND MODELS.**

SVP Driver Shield carries a standard six month warranty.

Information on this sheet is subject to change at the discretion of NFI Parts and/or its affiliates. Actual product may differ from photo. Contact your NFI Parts solutions manager or customer service representative for further details.
All product names, trademarks, and registered trademarks are property of their respective owners. NFI Parts disclaims any proprietary interest in the marks and names of others.

nfi.parts™
www.nfi.parts

NEW FLYER

U.S. & Canada
800.665.2637

MCI

U.S. 800.323.1290
Canada 800.665.0155
partsstore.nfi.parts

Driver Protection Systems

INFORMATION SHEET

nfi.parts™



MCI J4500 Coaches

NFI Parts Offers the Latest in Driver Protection Systems

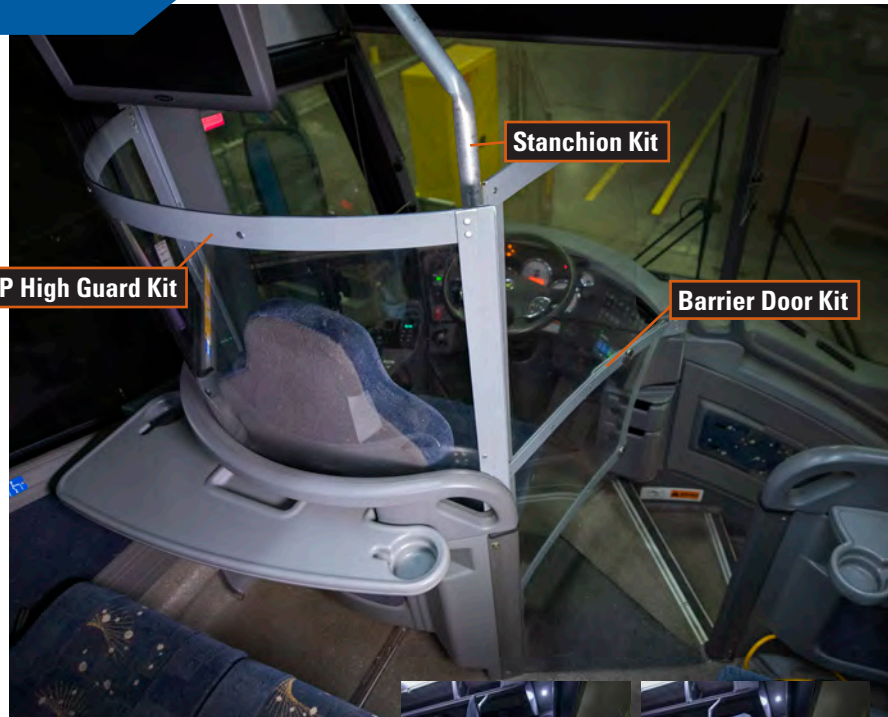

FEATURES

- Supports social distancing
- Protects drivers and riders
- Deflects projectiles
- Robust/permanent solution

Note: To build a full enclosure you will need a:

- **High Guard** (If you have the OE High Guard, you will also need the **Filler Panel**)
- **Stanchion** (to hang the door)
- **Door Kit** (if you have a 2018+ coach, you will need a **Closing Plate**)

PN / Status	Make	Model	Description
6482697	MCI	J4500	SVP High Guard Kit - Drivers Barrier, J Coach
03-02-1394SP	MCI	J4500 (2008 MY+)	OE High Guard w/Com P/Rack, W/15" LCD
6482959	MCI	J4500	Filler Panel (required for full barrier installation w/OE high guard installed)
6482925	MCI	J4500	Stanchion Kit (required for full barrier/door installation)
6485322	MCI	J4500	Drivers Barrier Door Kit, SVP, J Coach
6485321	MCI	J4500	Closing Plate, SVP, J45 2018+ (required with 6485322 on 2018+ J4500)

OTHER OPTIONS AVAILABLE, CALL FOR DETAILS

Information on this sheet is subject to change at the discretion of NFI Parts and/or its affiliates. Contact your NFI Parts solutions manager or customer service representative for further details. All product names, trademarks, and registered trademarks are property of their respective owners. NFI Parts disclaims any proprietary interest in the marks and names of others.

nfi.parts™
www.nfi.parts



U.S. & Canada
800.665.2637



U.S. 800.323.1290
Canada 800.665.0155
partsstore.nfi.parts

Driver Protection Systems

INFORMATION SHEET

nfi.parts™



MCI D Coaches

NFI Parts Offers the Latest in Driver Protection Systems

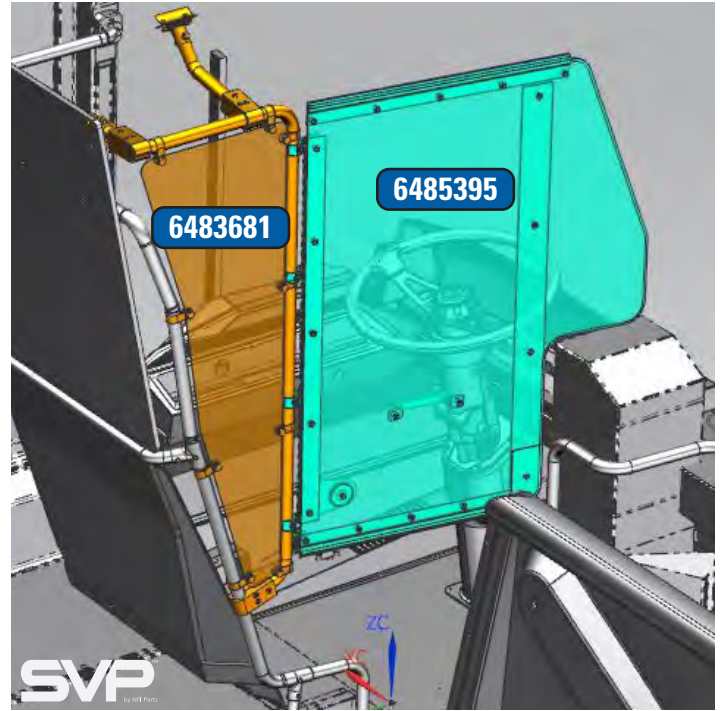

FEATURES

- Supports social distancing
- Protects drivers and riders
- Deflects projectiles
- Robust/permanent solution

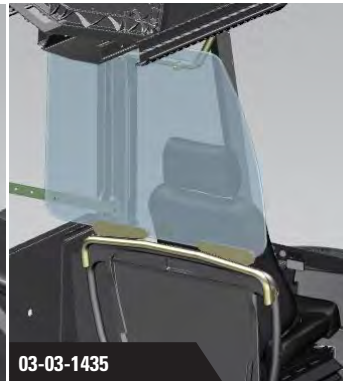
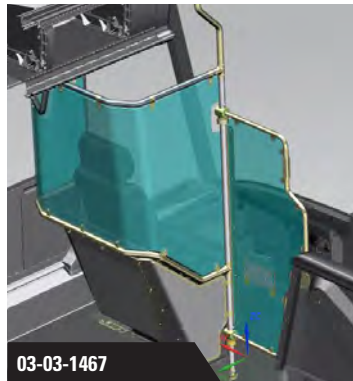

PN / Status	Make	Model	Description
03-03-1467	MCI	D4005/D4505 (2011 MY+)	Panel Inst'l - Drvr Mod, Aisle Gate, Sed/Dr, PU Pass Mod Pnl
6483681	MCI	D4500 (Prior 2015 MY)	Kit-Stanchion, D, Commuter SVP
6485395	MCI	D4500 (Prior 2015 MY)	Kit-Barrier, Door, D Commuter SVP - <i>must include 6483681</i>
03-03-1435	MCI	D4005/D4505 (2015 MY+)	High Guard Driver's Shield - Clear, Low Roof
03-03-1409	MCI	D4005/D4505 (2015 MY+)	High Guard Driver's Shield - Clear
03-03-1410	MCI	D4005/D4505 (2015 MY+)	High Guard Driver's Shield - Black
102038/A	MCI	D4505 (Non-commuter/Prior 2015 MY)	High Guard Driver's Shield

OTHER OPTIONS AVAILABLE, CALL FOR DETAILS

Information on this sheet is subject to change at the discretion of NFI Parts and/or its affiliates. Contact your NFI Parts solutions manager or customer service representative for further details. All product names, trademarks, and registered trademarks are property of their respective owners. NFI Parts disclaims any proprietary interest in the marks and names of others.

nfi.parts™
www.nfi.parts



U.S. & Canada
800.665.2637



U.S. 800.323.1290
Canada 800.665.0155
partsstore.nfi.parts

Retractable Partition

INFORMATION SHEET

nfi.parts™

MCI

NEW FLYER

A cost effective solution to enhance social distancing in buses and motor coaches.

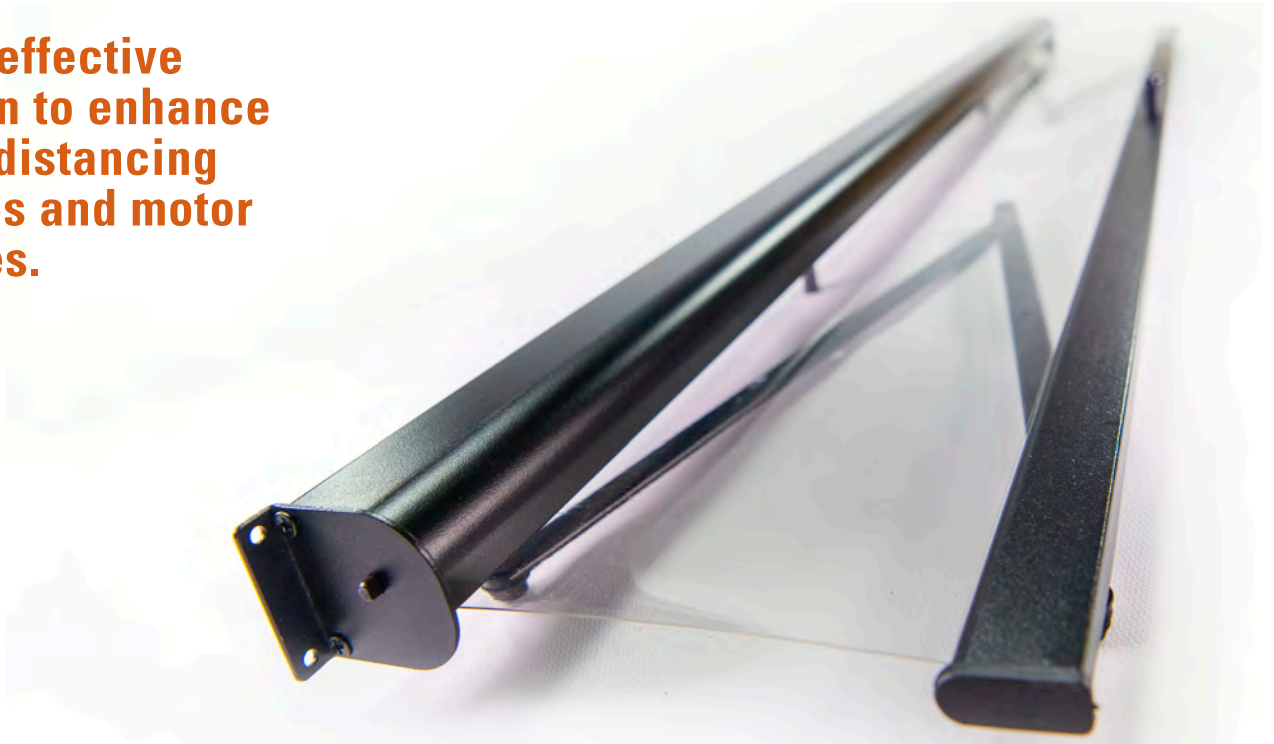

FEATURES

- Easy to install
- Many mounting options - can be easily mounted using standard hardware (no mounting hardware included)
- Durable steel construction
- Easy deployable partition*



**Not approved to be deployed in drivers line of sight while vehicle is in motion.*

NFI Part No.	Description
6482813	PARTITION - RETRACTABLE, CLEAR, 52" WIDE, 24" LONG
6482814	PARTITION - RETRACTABLE, CLEAR, 42" WIDE, 24" LONG
6482815	PARTITION - RETRACTABLE, CLEAR, 42" WIDE, 36" LONG

Information on this sheet is subject to change at the discretion of NFI Parts and/or its affiliates. Actual product may differ from photo. Contact your NFI Parts solutions manager or customer service representative for further details. All product names, trademarks, and registered trademarks are property of their respective owners. NFI Parts disclaims any proprietary interest in the marks and names of others.

nfi.parts™
www.nfi.parts

NEW FLYER

U.S. & Canada
800.665.2637

MCI

U.S. 800.323.1290
Canada 800.665.0155
partsstore.nfi.parts

Premium Passenger Seat Partition for MCI E/J Coach

INFORMATION SHEET

nfi.parts™



Support social distancing with a uniquely designed passenger partition that fits the underside contour of parcel racks



FEATURES

- Resilient vinyl sheeting - designed to provide a premium option for passenger protection
- Custom fit - minimizes exposure and maximizes coverage area
- High quality snaps provide a clean and secure fit
- Partition offers additional passenger coverage and protection
- Sturdy fiberglass perimeter border
- Easy to install and easy to clean with disinfectant liquids or wipes
- Flame retardant material meets the National Fire Protection Association NFPA701 and FMVSS302



Custom contoured design snaps to parcel rack for a precise fit in the MCI E/J4500 coach application

PN / Status	Description
6483953	PARTITION-PASSENGER SEAT, E/J

Information on this sheet is subject to change at the discretion of NFI Parts and/or its affiliates. Contact your NFI Parts solutions manager or customer service representative for further details. All product names, trademarks, and registered trademarks are property of their respective owners. NFI Parts disclaims any proprietary interest in the marks and names of others.

nfi.parts™
www.nfi.parts



U.S. & Canada
800.665.2637



U.S. 800.323.1290
Canada 800.665.0155
partsstore.nfi.parts

Retractable Belt Partition

INFORMATION SHEET

nfi.parts™

MCI

NEW FLYER

The cost effective solution to provide social distance in passenger areas on buses and motor coaches.



FEATURES

- Wall mounted version with included receiver
- 15' belt length
- Blocks off rows, seats, etc for social distancing
- Many mounting options - can be easily mounted using standard hardware
(no mounting hardware included)

NFI Part No.	Description
6482816	RETRACTABLE BELT PARTITION, 15' BELT LENGTH

Information on this sheet is subject to change at the discretion of NFI Parts and/or its affiliates. Actual product may differ from photo. Contact your NFI Parts solutions manager or customer service representative for further details. All product names, trademarks, and registered trademarks are property of their respective owners. NFI Parts disclaims any proprietary interest in the marks and names of others.

nfi.parts™
www.nfi.parts

NEW FLYER

U.S. & Canada
800.665.2637

MCI

U.S. 800.323.1290
Canada 800.665.0155
partsstore.nfi.parts

Interior Air Filters - Transit

INFORMATION SHEET

nfi.parts™

MCI

NEW FLYER

NFI Parts offers a wide variety of air filters to keep your fleet's interiors fresh and clean. We have the right filter to ensure your vehicles are comfortable for your passengers.



FEATURES

- Provides proper airflow throughout system
- Original OE specs will not void warranty
- Filters out common dust and pollen particles
- Easy to install

It is a good practice to change out your air filters every 3-6 months.

PN	Description	Size
637407	HVAC RETURN AIR, FILTER - XCELSIOR -MERV7	46" x 26.25"
636999	HVAC RETURN AIR, FILTER - XCELSIOR -MERV7	44.75" x 19.75"
404586	FILTER-HVAC POLYESTER - XCELSIOR -MERV7	46.5" x 26.5"
7700257	SVP PRE-CUT FILTER-HVAC POLYESTER - XCELSIOR -MERV7	46.5" x 26.5"
7700473	SVP FILTER ROLL -FLO FILTER MEDIA-30X 36'X 1 POLY - XCELSIOR -MERV7	30" x 36'
6482627	FILTER WITH TACKIFIER - XCELSIOR - MERV 8	46.5" x 26.5"
871752	FILTER-HVAC DACRON – XCELSIOR – MERV10	45.25 x 20.25 x 1"
872214	FILTER-HVAC DACRON – XCELSIOR – MERV10	46.50 x 26.75 x 1"

Information on this sheet is subject to change at the discretion of NFI Parts and/or its affiliates. Contact your NFI Parts solutions manager or customer service representative for further details. All product names, trademarks, and registered trademarks are property of their respective owners. NFI Parts disclaims any proprietary interest in the marks and names of others.

nfi.parts™
www.nfi.parts

NEW FLYER

U.S. & Canada
800.665.2637

MCI

U.S. 800.323.1290
Canada 800.665.0155
partsstore.nfi.parts

Antimicrobial Filter

INFORMATION SHEET

nfi.parts™

MCI

NEW FLYER

**OE Approved
airflow filter
with over 99.95%
effectiveness in
eliminating viruses
and bacteria**

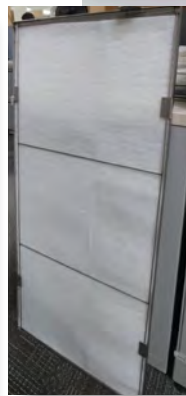

Patented-protected PuraWard® Antimicrobial Fiber Layer (PWF) - Kills 99.95% viruses by using a copper and silver ion property

How It Works

Copper ions weaken the amino acids of the cell wall allowing silver to invade the cell. The Copper and silver then react with key enzymes to cause sterilization, suffocation and starvation of the pathogen.

FEATURES

- Flow-rate tested and approved for MCI brand coach applications - will not harm fan motor
- No modifications needed - no need for filter frame reconstruction, can be cut and installed in existing filter assemblies
- UL 900, and ASHRAE Compliance
- Manufacture recommends a 3 month replacement schedule
- Typical coach uses ~10ft of material
- No shelf life for the anti-microbial coating – does not degrade over time

NFI Part No.	Description
6482974	FILTER-MERV8, W/PWF FIBERS, 90 FT ROLL (24" WIDE X .05" THICK)

**Also Available
Merv8 Filter
Roll Without
Antimicrobial Layer**



NFI Part No.	Description
6481593	EVAP FILTER ROLL, FILTER POLY FIBER - MERV8

Information on this sheet is subject to change at the discretion of NFI Parts and/or its affiliates. Actual product may differ from photo. Contact your NFI Parts solutions manager or customer service representative for further details. All product claims, names, trademarks, and registered trademarks are property of their respective owners. NFI Parts disclaims any proprietary interest in the marks and names of others.

nfi.parts™
www.nfi.parts

NEW FLYER

U.S. & Canada
800.665.2637

MCI

U.S. 800.323.1290
Canada 800.665.0155
partsstore.nfi.parts

MERV15 Filter Evaporator Kit for MCI J/D Coach

INFORMATION SHEET

nfi.parts™

MCI

NEW FLYER

Add new pleated
MERV rated filters to
your MCI E/J coach

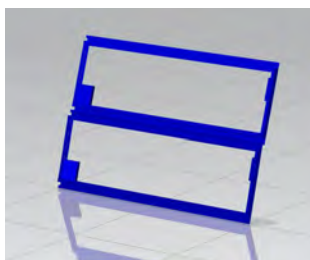

26-16-0045 kit framing shown

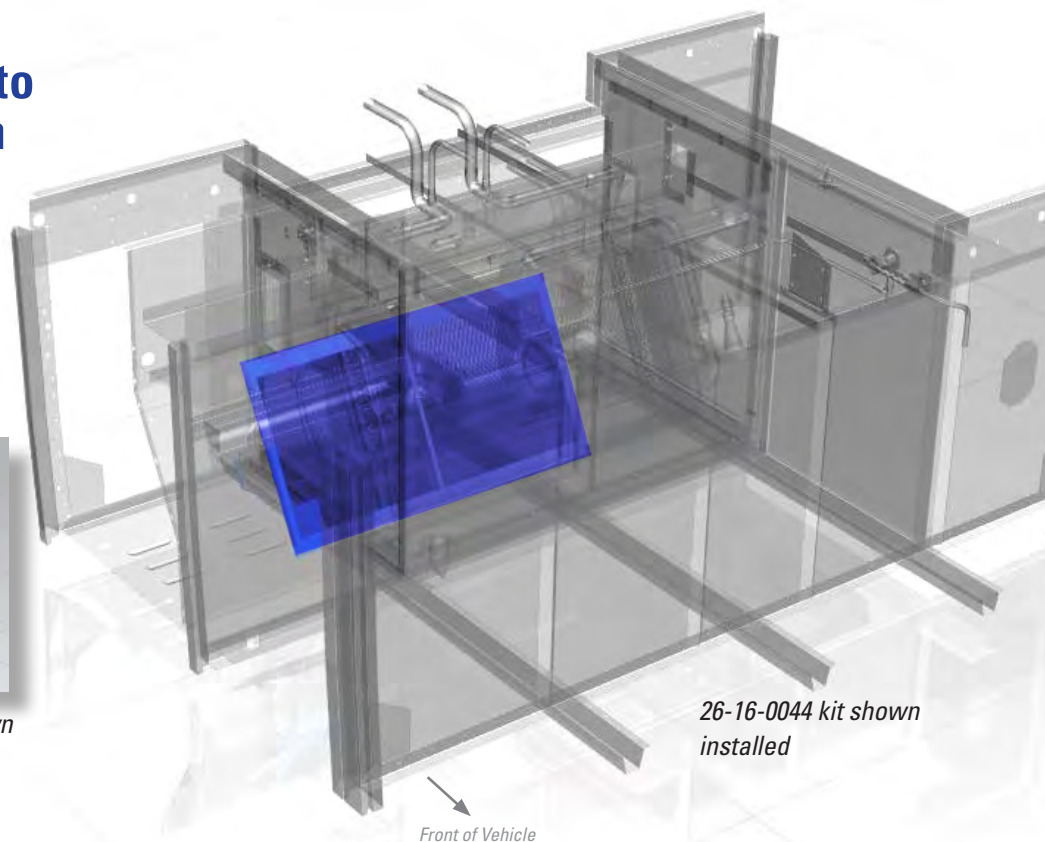

26-16-0044 kit shown
installed

Front of Vehicle

FEATURES

- Easy to install
- Kit creates a rigid frame to accept pleated MERV rated filters
- Fits all current production MCI J4500 Models and Legacy MCI D Coach

NFI Part No.	Description
26-16-0044	KIT - MERV 15 FILTER MAIN EVAP - MCI J4500
26-16-0045	KIT - MERV 15 FILTER MAIN EVAP - MCI LEGACY D

Information on this sheet is subject to change at the discretion of NFI Parts and/or its affiliates. Actual product may differ from photo. Contact your NFI Parts solutions manager or customer service representative for further details. All product claims, names, trademarks, and registered trademarks are property of their respective owners. NFI Parts disclaims any proprietary interest in the marks and names of others.

nfi.parts™
www.nfi.parts

NEW FLYER

U.S. & Canada
800.665.2637

MCI

U.S. 800.323.1290
Canada 800.665.0155
partsstore.nfi.parts

Parcel Rack Filter Retrofit Kit for MCI J/D Coach

INFORMATION SHEET

nfi.parts™

MCI

NEW FLYER

Increase the number of filter passes inside your MCI J/D coach

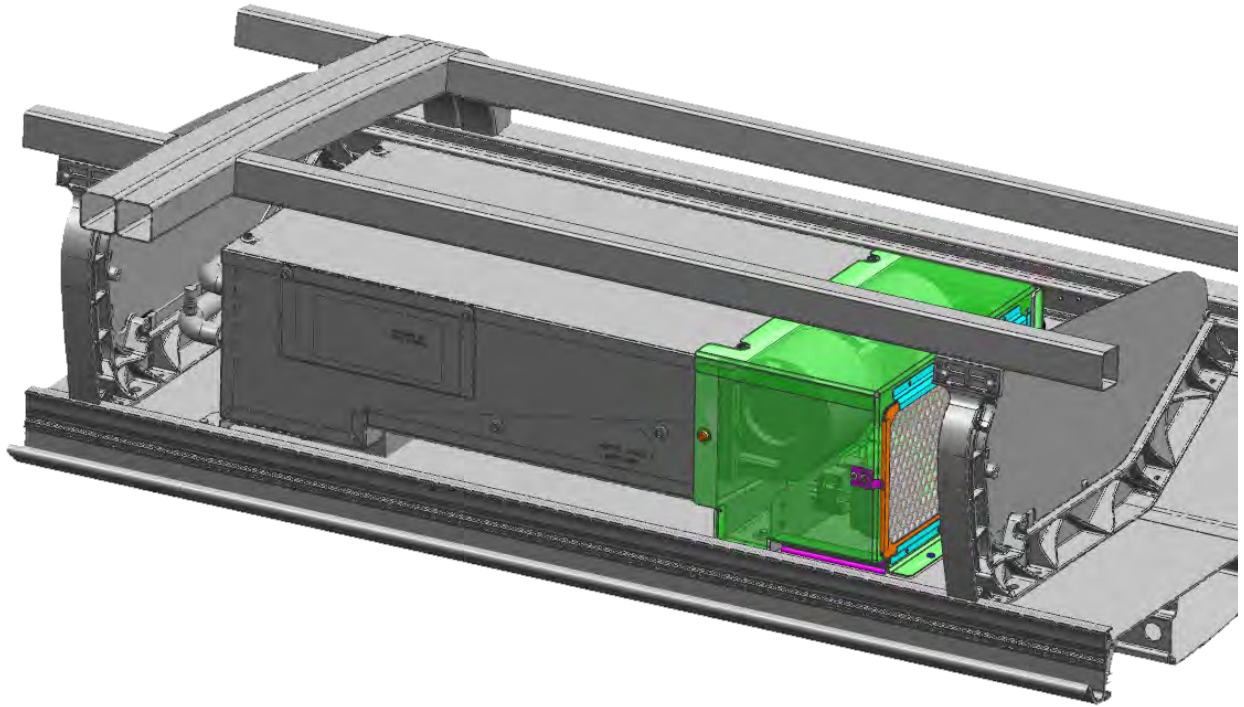

FEATURES

- Easy to install
- Creates housing for MERV rated filters for parcel rack evaporators
- Kit comes with left and right parcel assembly
- Fits all current production MCI Models

NFI Part No.	Description
26-16-0043	KIT-ENCLOSURE FILTRATION P/R EVAP - MERV 8
26-16-0046	KIT-ENCLOSURE FILTRATION P/R EVAP - MERV 15

Information on this sheet is subject to change at the discretion of NFI Parts and/or its affiliates. Actual product may differ from photo. Contact your NFI Parts solutions manager or customer service representative for further details. All product claims, names, trademarks, and registered trademarks are property of their respective owners. NFI Parts disclaims any proprietary interest in the marks and names of others.

nfi.parts™
www.nfi.parts

NEW FLYER

U.S. & Canada
800.665.2637

MCI

U.S. 800.323.1290
Canada 800.665.0155
partsstore.nfi.parts

Proactive Air and Surface Purification System

INFORMATION SHEET

nfi.parts™

MCI

NEW FLYER

Deactivates SARS-CoV-2 virus by sanitizing the AIR AND SURFACE without leaving any harmful residues!

Results from a study done by the University of Florida using the SARS-CoV-2 virus (which causes COVID-19) show after continuous exposure to this technology the virus becomes inactive.

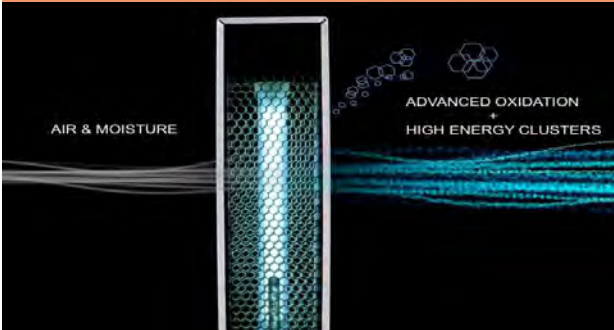

Fully contained unit replicates nature's eco-friendly purification process indoors by converting Air & Humidity into High Energy Clusters (HEC) and Advanced Bi-Polar Ion Oxidizers. Air is passed across proprietary UVX light and 6 metal honeycomb matrix, which is amplified by enhanced specular reflection, delivering unmatched pathogen elimination in the air and on surfaces.

Continuous disinfection from this unit promotes ridership confidence No down time or additional cleaning during service

FEATURES

- Effective on viruses, bacteria, mold, fungus, VOCs, mildew & odors
- Easy to install and maintain, can be placed in various locations on the vehicle - uses 12V DC power
- Buy America Compliant
- Easy filter replacement every three months, cell replacement once every year
- Does not void supplier warranty of HVAC systems
- One Year Warranty

NFI Part No.	Description
6483801	KIT-PURIFIER-AIR/SURFACE
Service Parts	
6483852	CELL-PURIFICATION SYSTEM
6483853	FILTER-PURIFICATION SYSTEM 12-PK
6484812	FAN-PURIFICATION SYSTEM

*Laboratory, testing, validations, and claims have been made by manufacturer. Documentations can be supplied upon request.
Information on this sheet is subject to change at the discretion of NFI Parts and/or its affiliates. Contact your NFI Parts solutions manager or customer service representative for further details.
All product names, trademarks, and registered trademarks are property of their respective owners. NFI Parts disclaims any proprietary interest in the marks and names of others.

nfi.parts™
www.nfi.parts

NEW FLYER

U.S. & Canada
800.665.2637

MCI

U.S. 800.323.1290
Canada 800.665.0155
partsstore.nfi.parts

Proactive Air and Surface Purification System

INFORMATION SHEET

nfi.parts™

MCI

NEW FLYER

Is it Safe?

System is certified as safe to use in occupied spaces, validated by leading independent laboratories and health organizations globally.

Extensively tested and qualified under the rigorous standards of CDC, OSHA, FDA, and the EPA. In fact, successful testing at the University of Florida shows its technology deactivates SARS-CoV-2, the virus that causes COVID-19, as well as deactivating coronavirus 229E.

How it Works

Air + Humidity ⇌ HEC + Oxidizers

This active technology creates High Energy Clusters (HEC) and Advanced Bi-Polar Ion Oxidizers that destroy dangerous pathogens at the cellular level in the air we breathe and on the surfaces we touch. This unit works on its own while the vehicle is in use. Does not require additional downtime or disinfecting labor during service.

Air and Surface!

The system continuously purifies Air AND Surfaces.

Air flows in to the unit creating HEC and Oxidizers that leave the system and attack pathogens in the air and on surfaces.

*Laboratory, testing, validations, and claims have been made by manufacturer. Documentations can be supplied upon request.
Information on this sheet is subject to change at the discretion of NFI Parts and/or its affiliates. Contact your NFI Parts solutions manager or customer service representative for further details.
All product names, trademarks, and registered trademarks are property of their respective owners. NFI Parts disclaims any proprietary interest in the marks and names of others.

nfi.parts™
www.nfi.parts

NEW FLYER

U.S. & Canada
800.665.2637

MCI

U.S. 800.323.1290
Canada 800.665.0155
partsstore.nfi.parts

Proactive Air and Surface Purification System

INFORMATION SHEET

nfi.parts™



The Details:

- Disinfects without down time or additional cleaning during service; once it has been installed and the vehicle is running, it continuously disinfects while the vehicle is on the road
- Continuously disinfects air AND surfaces including hard to reach places while the vehicle is in service
- Effective on viruses, bacteria, mold, fungus, VOCs, mildew & odors
- Proven effective against SARS-CoV-2 (which causes COVID-19) & Coronavirus 229E by University of Florida, Department of Medicine
- Coverage range is up to 30,000 cubic feet (60' transit bus is approx. ~4,000ft³)
- Extensively tested using the standards of FDA, CDC, EPA, OSHA, KSU, UoF, NSF
- Safe to run with passengers onboard the vehicle
- Unit is visible to riders, building confidence regarding their safety
- Does not leave harmful residue
- Easy to install and maintain, can be placed in various locations on the vehicle
- Technology is contained within unit
- Does not void supplier warranty of HVAC systems
- Does not impact other vehicle systems
- Buy America Compliant
- Easy filter replacement every three months, cell replacement every 12-18 months depending on your fleet's actual operational duty cycle
- One Year Warranty

The Research: The Most Validated Purifier on the Market

Researchers at the University of Florida, Department of Medicine found that the proactive air and surface purification technology inactivates 73.33% of infectious high levels of SARS-CoV-2 on stainless steel surfaces within only 15 minutes of exposure to the technology, 93.3% after 60 minutes, 97.7% after 4 hours, and undetectable with 24 hours of exposure.*

Results from the University of Florida study are consistent with those of an independent study done by Central Michigan University and Insight Research Institute which tested the effectiveness of the technology using cell cultures of coronavirus 229E and dengue, both used as surrogate viruses for SARS-CoV-2. This study concluded that there were morphological changes that had realigned the monolayer of A549 cells, seen in coronavirus 229E after exposure to this technology.

It is unique from other disinfection technologies (chemical cleaning, UV light, vaporized hydrogen peroxide) because it is used continuously. There are no downtime periods, chemical handling procedures, harmful residues, room clearance protocols, manpower requirements or adverse side effects. Using ambient air, the technology creates non thermal plasma that reduces pathogens safely while people are in the vehicle. It is the most validated purifier on the market. In addition to SARS-CoV-2, this technology has also been shown to be effective against many other pathogens including H1N1, E. coli, MRSA, Listeria, c difficile, staph, etc.

*Laboratory, testing, validations, and claims have been made by manufacturer. Documentations can be supplied upon request.

Information on this sheet is subject to change at the discretion of NFI Parts and/or its affiliates. Contact your NFI Parts solutions manager or customer service representative for further details. All product names, trademarks, and registered trademarks are property of their respective owners. NFI Parts disclaims any proprietary interest in the marks and names of others.

nfi.parts™
www.nfi.parts



U.S. & Canada
800.665.2637



U.S. 800.323.1290
Canada 800.665.0155
partsstore.nfi.parts

UV-C Lighting Kits for Motorcoaches

INFORMATION SHEET

nfi.parts™

MCI

NEW FLYER

The smart answer to reducing viruses, bacteria and mold in the HVAC system.

Durable, cost effective and reliable. Offers an improved safety focused environment for drivers and passengers.

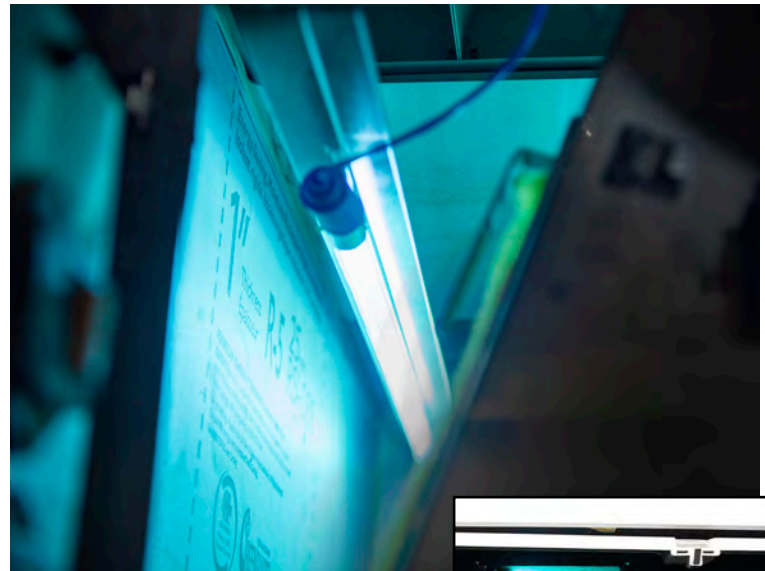

Main Evaporator Install



Parcel Rack Install

FEATURES

- High-cycle commercial grade ballast
- Simple installation into most main evaporator compartments
- UV-C lamp reduces viruses, bacteria, and mold in the air and on the HVAC coil by 99.9%
- Does not use harmful chemicals
- Produces no pollution
- Powered by high-powered ballast in a conveniently small size



**Kits contain dedicated 110V inverter for the light system.
All harnessing and mounting hardware included.**

NFI Part No.	Description
6482663	KIT-LAMP, UV-C, MAIN EVAP, J4500
6482664	KIT-LAMP, UV-C, MAIN PLUS P/R EVAP, J4500
6482665	KIT-LAMP, UV-C, MAIN EVAP, D-COACH
6482666	KIT-LAMP, UV-C, MAIN PLUS P/R EVAP, D-COACH
6484336	KIT-LAMP, UV-C, MAIN EVAP, PREVOST H3

Information on this sheet is subject to change at the discretion of NFI Parts and/or its affiliates. Actual product may differ from photo. Contact your NFI Parts solutions manager or customer service representative for further details. All product names, trademarks, and registered trademarks are property of their respective owners. NFI Parts disclaims any proprietary interest in the marks and names of others.

nfi.parts™
www.nfi.parts

NEW FLYER

U.S. & Canada
800.665.2637

MCI

U.S. 800.323.1290
Canada 800.665.0155
partsstore.nfi.parts

Power Vented Safety Roof Hatch Kit

INFORMATION SHEET

nfi.parts™

MCI

NEW FLYER

Add ventilation and improve passenger comfort.

The power safety vent is a combination emergency exit and roof ventilator that utilizes the built in electric fan for extracting condensation, stale or hot air from inside the vehicle to improve passenger safety.



Straightforward Installation



Simply remove your existing roof hatch lid from your existing bezel and install the new power lids



Run Power and Switch Circuit



Install Switch

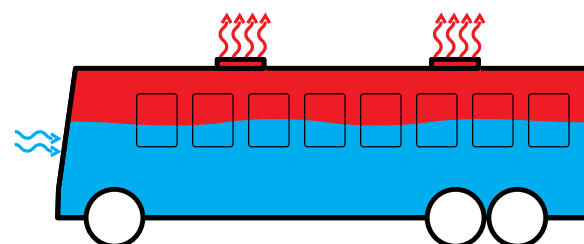

Allows fresh air to circulate

FEATURES

- Constructed of high strength UV stable materials
- Universal fit application - fits most transit buses and motor coaches (MCI VIN 65000+) with an existing 24" x 24" manual roof hatch (not compatible with the motorized roof hatches)
- Creates a powerful airflow and cross breeze with a durable low profile fan
- Available in white (typical transit applications) or gray (typical motor coach applications) interior color

NFI Part No.	Description
6482386	POWERED ROOF HATCH KIT (INCLUDES TWO POWER LIDS, HARNESSSES, DASH SWITCH AND INSTRUCTIONS) - GREY
6482437	POWERED ROOF HATCH KIT (INCLUDES TWO POWER LIDS, HARNESSSES, DASH SWITCH AND INSTRUCTIONS) - WHITE
6344894	ENGLISH DECAL
6349302	ENGLISH/SPANISH DECAL
6351298	FRENCH DECAL

Information on this sheet is subject to change at the discretion of NFI Parts and/or its affiliates. Contact your NFI Parts solutions manager or customer service representative for further details. All product names, trademarks, and registered trademarks are property of their respective owners. NFI Parts disclaims any proprietary interest in the marks and names of others.

nfi.parts™
www.nfi.parts

NEW FLYER

U.S. & Canada
800.665.2637

MCI

U.S. 800.323.1290
Canada 800.665.0155
partsstore.nfi.parts

Seat Bands

INFORMATION SHEET

nfi.parts™



Help passengers social distance with seat bands

Plan your social distancing strategy for customer safety with these versatile seat bands. Elasticated fabric stretches to secure the hidden J-Hook fastener for a tight fit to the seat.



FEATURES

- Easy to install
- Easy to clean vinyl
- Fits most seats
- Strap remains secure during service

Versatile

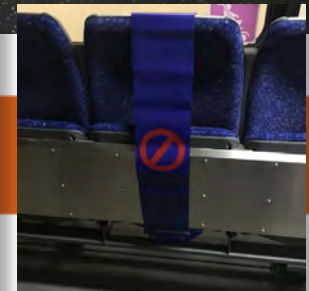

Easy to install

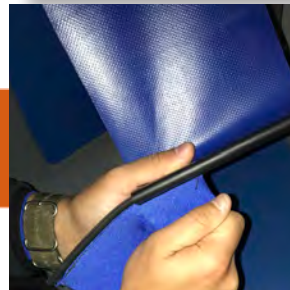

NFI Part No.	Description
6484827	BAND-SEAT DO NOT SIT HERE LONGITUDINAL

Information on this sheet is subject to change at the discretion of NFI Parts and/or its affiliates. Actual product may differ from photo. Contact your NFI Parts solutions manager or customer service representative for further details. All product claims, names, trademarks, and registered trademarks are property of their respective owners. NFI Parts disclaims any proprietary interest in the marks and names of others.

nfi.parts™
www.nfi.parts



U.S. & Canada
800.665.2637



U.S. 800.323.1290
Canada 800.665.0155
partsstore.nfi.parts

Product Decal - For Your Safety

INFORMATION SHEET

nfi.parts™



Show your commitment to safety and increase confidence in Bus and Coach travel.



FOR YOUR SAFETY
This bus has been equipped with the following:

- ✓ Hydrogen Peroxide Air Purification
- ✓ Sanitizing UV-C Lighting
- ✓ Antimicrobial Air Filters
- ✓ Fresh Air Circulating Roof Vents
- ✓ On-Board Hand Sanitizer
- ✓ On-Board Mask Dispenser
- ✓ Physical Distancing Partitions
- ✓ Disinfecting Technology

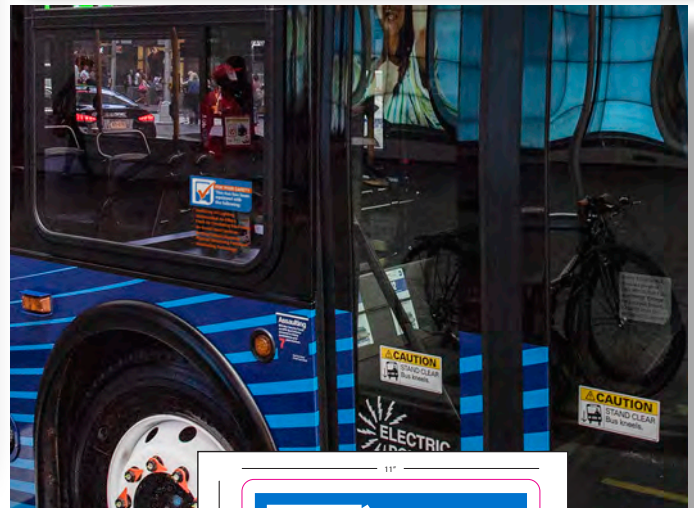

FOR YOUR SAFETY
This bus has been equipped with the following:

- ✓ Hydrogen Peroxide Air Purification
- ✓ Sanitizing UV-C Lighting
- ✓ Antimicrobial Air Filters
- ✓ Fresh Air Circulating Roof Vents
- ✓ On-Board Hand Sanitizer
- ✓ On-Board Mask Dispenser
- ✓ Physical Distancing Partitions
- ✓ Disinfecting Technology

FEATURES

- Easy peel and stick window cling
- Pick and choose the safety items where you have invested

How It Works

Select the products you employ in your safety program from the window cling sheet.

NFI Part No.	Description
6483560	DECAL - FOR YOUR SAFETY (10" WIDE)

Information on this sheet is subject to change at the discretion of NFI Parts and/or its affiliates. Actual product may differ from photo. Contact your NFI Parts solutions manager or customer service representative for further details. All product claims, names, trademarks, and registered trademarks are property of their respective owners. NFI Parts disclaims any proprietary interest in the marks and names of others.

nfi.parts™
www.nfi.parts



U.S. & Canada
800.665.2637



U.S. 800.323.1290
Canada 800.665.0155
partsstore.nfi.parts

Decals - Social Distance

INFORMATION SHEET

nfi.parts™

MCI

NEW FLYER



6483289



6483296



6483293



6483299



6483314



6483308



6483305



6483302



6483311

FEATURES

- Easy peel and stick
- Pick and choose the messaging you need



6483317



6483290

PN - English	PN - English/Spanish	PN - English/French	Description
	6483289		DECAL-COVID LTD SEATING AVAIL W/CABLE TIES-EN/SP-8.5"X11"
6483296	6483297	6483298	DECAL-DO NOT BOARD W/ SYMPTOMS 13"X7.5"25PK
6483293	6483294	6483295	DECAL- MAINTAIN A SAFE DISTANCE 11"X4"25PK
6483299	6483300	6483301	DECAL-DO NOT USE THIS SEAT 11"X 4"50PK
6483314	6483315	6483316	DECAL- WASH YOUR HANDS BEFORE/AFTER 9.5"X4"25PK
6483308	6483309	6483310	DECAL-DO NOT APPROACH THE OPERATOR 9.5"X4"25PK
6483305	6483306	6483307	DECAL- FACE COVER/FACE MASK USE IS RECOM 9.5"X4"25PK
6483311	6483312	6483313	DECAL-DO NOT PASS THIS POINT 19.5"X4"25PK
6483302	6483303	6483304	DECAL-CLOTH FACE COVERING/MASK USE IS REQD 9.5" X 4"25PK
6483317	6483318	6483319	DECAL-STAND HERE - 10" X 10"
6483290	6483291	6483292	DECAL- VEHICLE IS CLEAN/SANITIZED-9.5"X4" 25PK

Information on this sheet is subject to change at the discretion of NFI Parts and/or its affiliates. Actual product may differ from photo. Contact your NFI Parts solutions manager or customer service representative for further details. All product claims, names, trademarks, and registered trademarks are property of their respective owners. NFI Parts disclaims any proprietary interest in the marks and names of others.

nfi.parts™
www.nfi.parts

NEW FLYER

U.S. & Canada
800.665.2637

MCI

U.S. 800.323.1290
Canada 800.665.0155
partsstore.nfi.parts

Fogging Products

INFORMATION SHEET

nfi.parts™

MCI

NEW FLYER

Hand-held disinfectant fogger for an efficient and effective way to quickly sanitize vehicles, shops and offices.



FEATURES

- Effective on surfaces and in the air.
- Strong injection and ultra-low volume spraying function ensures the penetration and diffusion to fine areas.
- Fast and affective air and surface treatment - 5-10 meters.
- 3 liter solution reservoir - sanitizes five vehicles before refilling.
- Proven technology with no special PPE required.

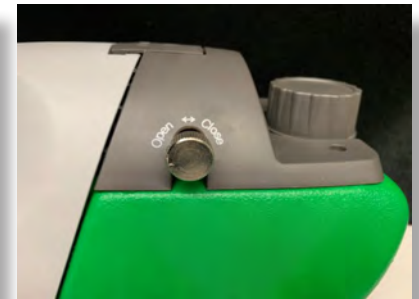

NFI Part No.	Description
6482773	ENVIRONIZE ULV FOGGER, CORDED
6483398	SOLUTION-ENVIROCLEANSE - 4X 1 GAL JUGS

Information on this sheet is subject to change at the discretion of NFI Parts and/or its affiliates. Actual product may differ from photo. Contact your NFI Parts solutions manager or customer service representative for further details. All product names, trademarks, and registered trademarks are property of their respective owners. NFI Parts disclaims any proprietary interest in the marks and names of others.

nfi.parts™
www.nfi.parts

NEW FLYER

U.S. & Canada
800.665.2637

MCI

U.S. 800.323.1290
Canada 800.665.0155
partsstore.nfi.parts

Clean and Protect Products

INFORMATION SHEET

nfi.parts™

MCI

NEW FLYER

Provide your staff and customers with key products to help maintain a clean environment.



FEATURES

- Secured, universal dispensers
- Disposable masks convenient for rider and driver use. (individually packaged)
- Disposable Nitrile gloves masks
- Simple and accessible options increase safety

NFI Part No.	Description
6482811	MASK - INDIVIDUALLY WRAPPED, PLEATED, EAR STRAPS, BOX OF 100PCS
6482812	MASK - INDIVIDUALLY WRAPPED, PLEATED, EAR STRAPS, BOX OF 500PCS
6482976	MASK DISPENSER, UNIVERSAL WALL MOUNT
6482810	UNIVERSAL WALL MOUNT WIPE CONTAINER, ACRYLIC
6483270	GLOVES - MEDIUM, NITRILE 5MIL 100/BX
6483271	GLOVES - LARGE, NITRILE 5MIL 100/BX
6483272	GLOVES - XLARGE, NITRILE 5MIL 100/BX
6483589	BOTTLE - SPRAY 24OZ PLASTIC
6483590	TRIGGER - FOR SPRAY BOTTLE 24OZ PLASTIC

Information on this sheet is subject to change at the discretion of NFI Parts and/or its affiliates. Actual product may differ from photo. Contact your NFI Parts solutions manager or customer service representative for further details. All product names, trademarks, and registered trademarks are property of their respective owners. NFI Parts disclaims any proprietary interest in the marks and names of others.

nfi.parts™
www.nfi.parts

NEW FLYER

U.S. & Canada
800.665.2637

MCI

U.S. 800.323.1290
Canada 800.665.0155
partsstore.nfi.parts

Disposable Plastic Bags

INFORMATION SHEET

nfi.parts™

MCI

NEW FLYER

Upgrade your bus or coach for greater passenger convenience and less mess!



FEATURES

- Easy to install
- Reloads quickly
- Multiple uses and location options



NFI Part No.	Description
T21-2459	12X18* WHITE DISPOSABLE BAG - KIT (INCLUDES HANGER AND 50 BAGS)
T21-2386	12X18* WHITE DISPOSABLE BAG - CASE QTY. = 2,000 BAGS (40 BUNDLES)
T21-2451	9.5X13* BIODEGRADABLE GREEN DISPOSABLE BAG - CASE QTY. = 4,000 BAGS (80 BUNDLES)
T21-1084	9.5X13* WHITE DISPOSABLE BAG - CASE QTY. = 4,000 BAGS (80 BUNDLES)
3L-15-708	HANGER

Information on this sheet is subject to change at the discretion of NFI Parts and/or its affiliates. Actual product may differ from photo. Contact your NFI Parts solutions manager or customer service representative for further details. All product names, trademarks, and registered trademarks are property of their respective owners. NFI Parts disclaims any proprietary interest in the marks and names of others.

nfi.parts™
www.nfi.parts

NEW FLYER

U.S. & Canada
800.665.2637

MCI

U.S. 800.323.1290
Canada 800.665.0155
partsstore.nfi.parts

Celeste® Sanitizer Products - SaniLuxe Hand Sanitizer

INFORMATION SHEET

nfi.parts™

MCI

NEW FLYER

**The mount
anywhere hand
sanitizer for
operators and
passengers safety**



FEATURES

- Mild, gentle, moisturizing formula that does not dry out skin
- Contains emollients to leave hands feeling soft
- No need to rinse
- Easy viewing of sanitizer level
- Quick and easy bottle replacement

**Mounts Easy on
Any Flat Surface**

- Drivers Areas
- Wheel Wells
- Lavatories

NFI Part No.	Description
T23-1026	SANITIZER-HAND,WATERLESS CS=32 (10 OZ.) BOTTLES
T23-1018	BASE HOLDER - COUNTER TOP, ANGLED BASE
T23-1022	BASE HOLDER - COUNTER TOP, STANDARD BASE

Information on this sheet is subject to change at the discretion of NFI Parts and/or its affiliates. Contact your NFI Parts solutions manager or customer service representative for further details. All product names, trademarks, and registered trademarks are property of their respective owners. NFI Parts disclaims any proprietary interest in the marks and names of others.

nfi.parts™
www.nfi.parts

NEW FLYER

U.S. & Canada
800.665.2637

MCI

U.S. 800.323.1290
Canada 800.665.0155
partsstore.nfi.parts

Celeste® Sanitizer Products - Sani-Cide EX3

INFORMATION SHEET

nfi.parts™

MCI

NEW FLYER

An EPA registered broad-spectrum disinfectant and multi-purpose cleaner. It offers a safe and effective approach to the disinfection of a variety of surfaces throughout the vehicle while cleaning multi-soils leaving behind a clean, streak and haze free surface.

FEATURES

- Biodegradable
- Non-toxic and non-corrosive
- No quaternary ammonium compounds
- Water based, contains no volatile organic compounds (VOCs)
- Does not contribute to an accumulated grimy/dulled appearance
- Highly effective performance—shows substantial soil removal and minimal soil re-deposition—contains agents that prevent soil re-deposition and make subsequent cleaning easier
- Safe for use on glass, mirrors, metal, plastic, leather, fabric, and carpet
- Non-reactive to and fully compatible with all known fire retardant thermoplastics



NFI Part No.	Description
6482480	SANI-CIDE-EX3,CASE=(12) 1 QT BTL
6482481	SANI-CIDE-EX3,CASE+(4) 1 GAL JUG
6482483	SANI-CIDE-EX3,5 GAL PAIL

Information on this sheet is subject to change at the discretion of NFI Parts and/or its affiliates. Contact your NFI Parts solutions manager or customer service representative for further details. All product names, trademarks, and registered trademarks are property of their respective owners. NFI Parts disclaims any proprietary interest in the marks and names of others.

nfi.parts™
www.nfi.parts

NEW FLYER

U.S. & Canada
800.665.2637

MCI

U.S. 800.323.1290
Canada 800.665.0155
partsstore.nfi.parts